

6 5 4 3 2 1

D D

C C

B B

A A

6 5 4 3 2 1

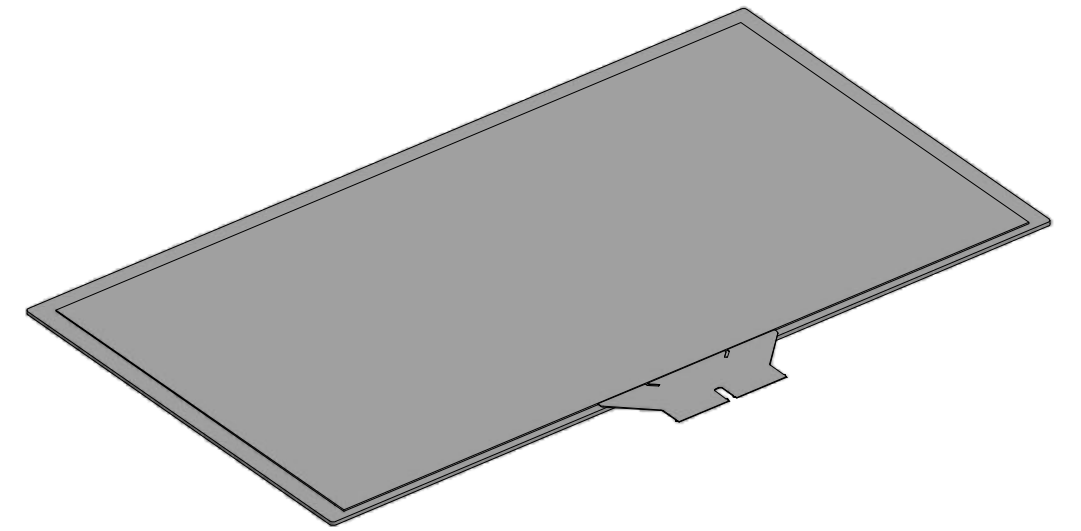
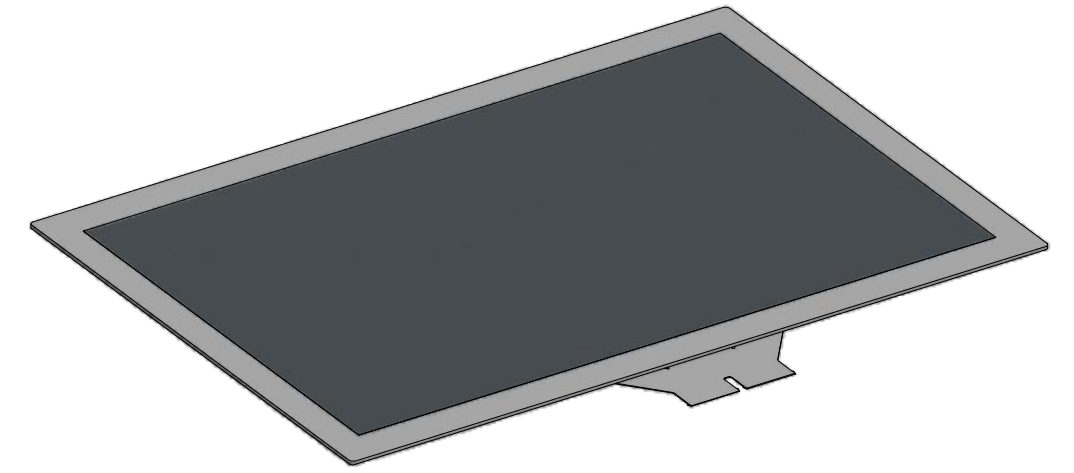

REVISION HISTORY					
Version	REV	DESCRIPTION		DATE	APPROVED
A	01	initial		2019-05-06	kschmid
	DATE	NAME	TITLE:	SCALE:	WEIGHT:
DRAWN:	2019-05-05	jmarzt	IX-TP240-800-A01	2:5	N/A
CHECKED:	2019-05-06	dmueller		MATERIAL:	SHEET:
APPROVED:	2019-05-06	kschmid			1
INTERELECTRONIX			DRAWING NUMBER:	UNLESS OTHERWISE SPECIFIED DIMENSION ARE IN MILLIMETERS	SIZE:
			IX-TP240-800-A01	TOLERANCE CLASSES:	A3
				DIN ISO 2768-1: m	 EUROPEAN PROJECTION
				DIN ISO 2768-2: K	
<small>Copyright according to ISO 16016 Passing on and copying of this document, utilization and communication of its content is not permitted, unless expressly allowed. Offenders will be liable for compensation. All rights reserved for IP application.</small>					

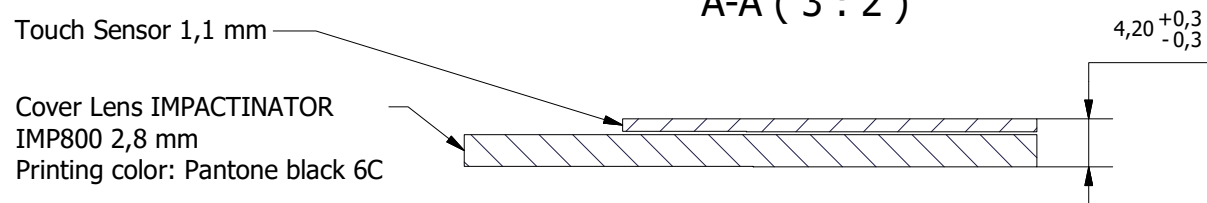
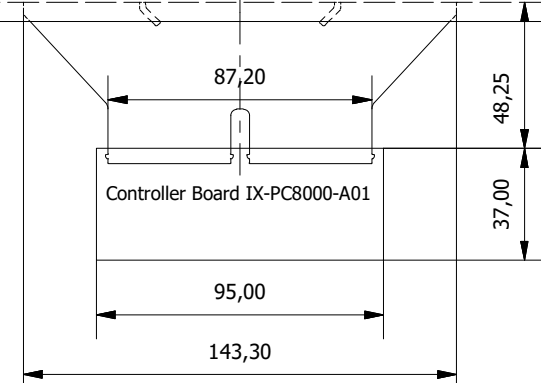
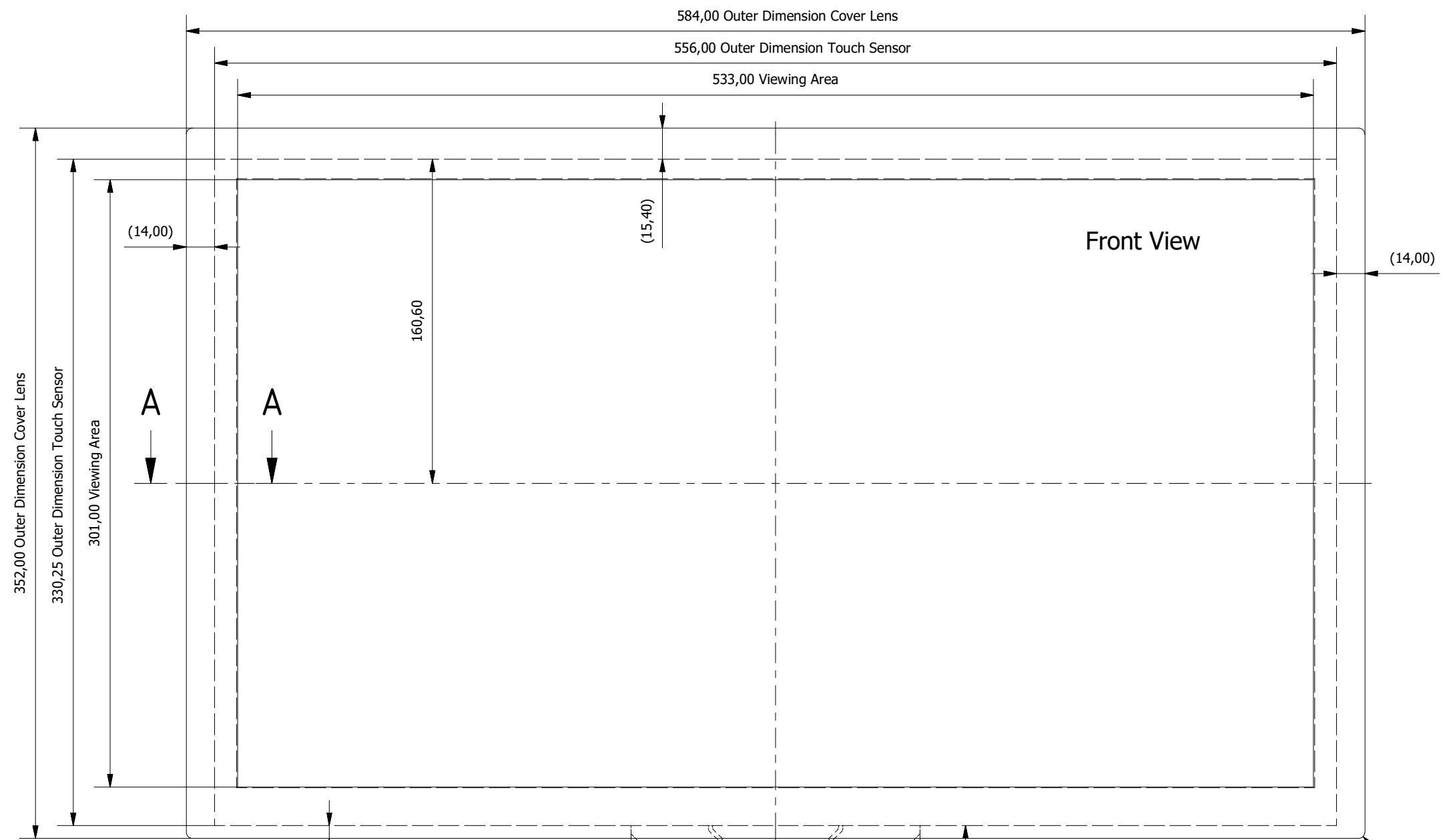
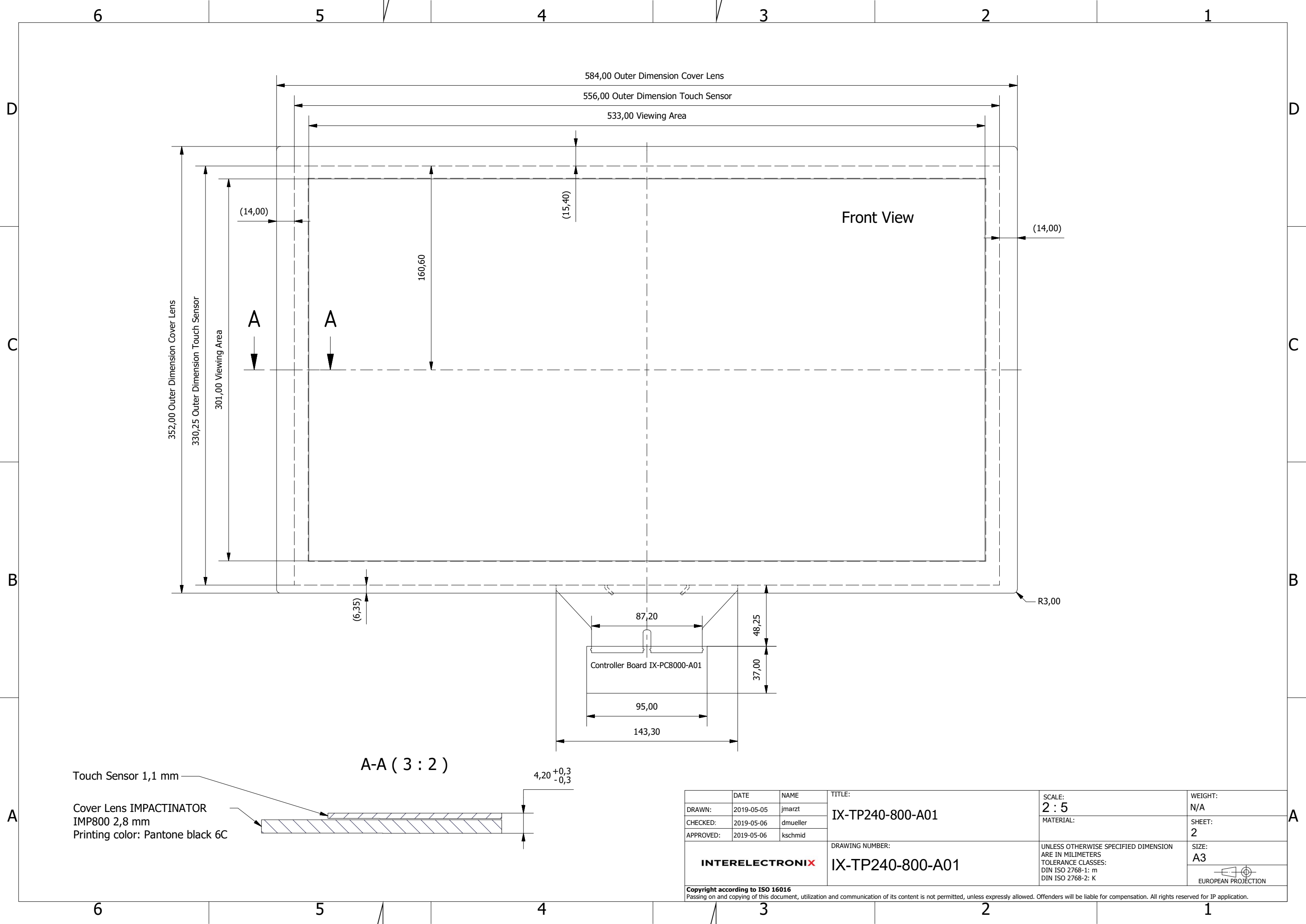

	DATE	NAME	TITLE:	SCALE:	WEIGHT:
DRAWN:	2019-05-05	jmarzt	IX-TP240-800-A01	2 : 5	N/A
CHECKED:	2019-05-06	dmueller		MATERIAL:	SHEET:
APPROVED:	2019-05-06	kschmid			2
INTERELECTRONIX			DRAWING NUMBER:	UNLESS OTHERWISE SPECIFIED DIMENSION ARE IN MILLIMETERS TOLERANCE CLASSES: DIN ISO 2768-1: m DIN ISO 2768-2: K	SIZE: A3
<small>Copyright according to ISO 16016 Passing on and copying of this document, utilization and communication of its content is not permitted, unless expressly allowed. Offenders will be liable for compensation. All rights reserved for IP application.</small>			IX-TP240-800-A01		 EUROPEAN PROJECTION